

Halo Circular

Design by Martín Azúa

A seamless merging of light and matter, Halo lends the effect of light floating in air. Powered by LED bulbs that remain invisible within their opalized, spherical moulds, the light flows freely from its source.

Pendants



ø 55,5 cm

2330



89 cm

2331

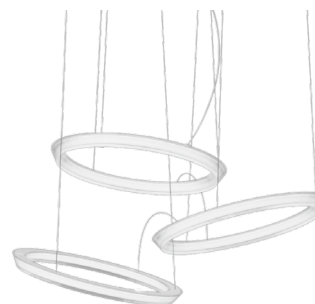

127 cm

2332

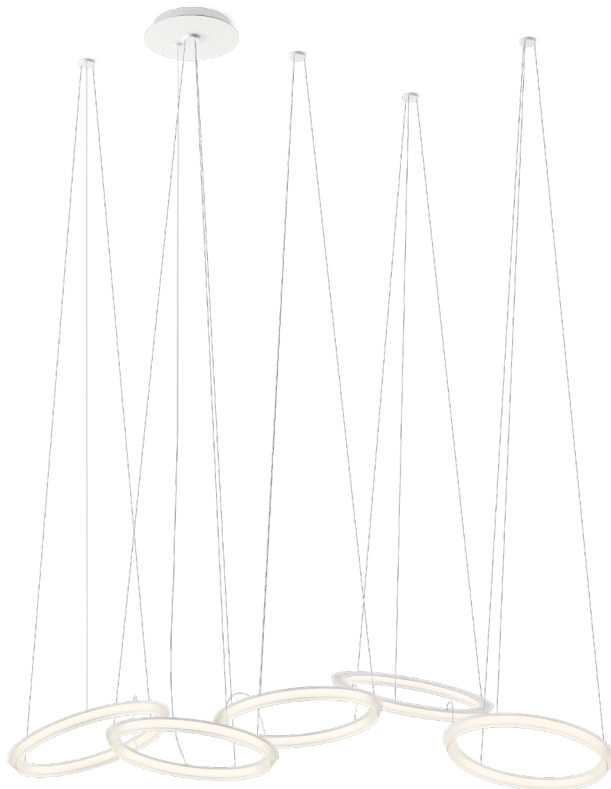

197 cm

2333

Each project is unique.
Personalise your own
Halo composition
quick and easy.

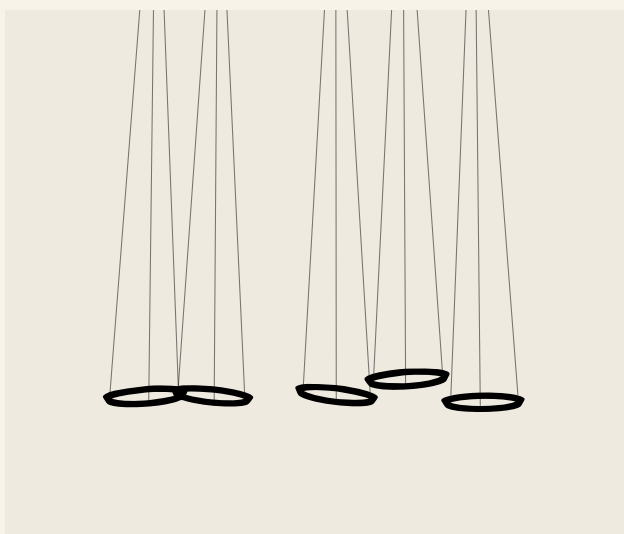
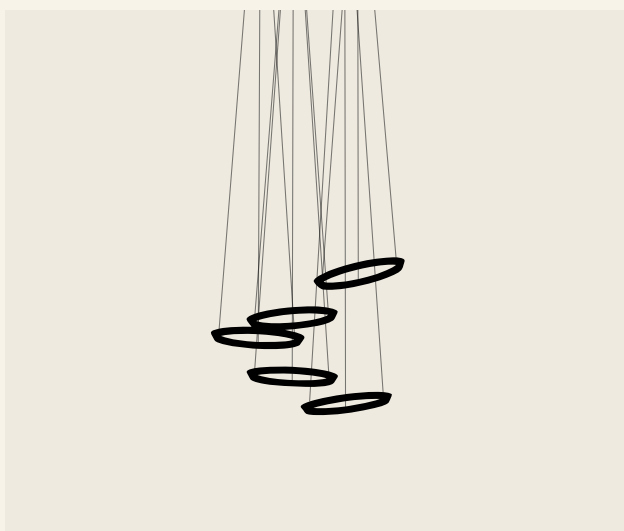

2330

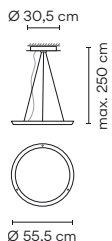

Finishes

- 03/ __ White (RAL 9016)

LED temperature colour

- /1_ 2700 K CRI >90 1904 lm 82 lm/W
- /2_ 3000 K CRI >80 1726,78 lm 75 lm/W

Control

- 2330 __ / _ 1 DALI
- 2330 __ / _ 3 1-10V
- 2330 __ / _ Z Casambi

Materials

Diffuser: PMMA. Canopy: Steel

Light Source and electronics

1 x LED STRIP 24V 23 W
Constant Voltage 24V
100~277V 50/60Hz

Packaging

1 Box 0,60 x 0,60 x 0,27 m
Vol 0,0972 m³
Gross weight 5,75 Kg Net weight 3,75 Kg



2331

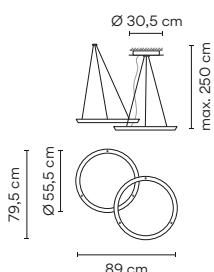

Finishes

- 03/ __ White (RAL 9016)

LED Colour Temperature

- /1_ 2700 K CRI >90 3808 lm 82 lm/W
- /2_ 3000 K CRI >80 3453,56 lm 75 lm/W

Control

- 2331 __ / _ 1 DALI
- 2331 __ / _ 3 1-10V
- 2331 __ / _ Z Casambi

Materials

Diffuser: PMMA. Canopy: Steel

Light Source and electronics

2 x LED STRIP 24V 23 W
Constant Voltage 24V
100~277V 50/60Hz

Packaging

1 Box 0,60 x 0,60 x 0,27 m
Vol 0,0972 m³
Gross weight 10,25 Kg Net weight 6,25 Kg



2332

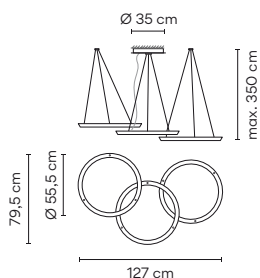

Finishes

- 03/ __ White (RAL 9016)

LED Colour Temperature

- /1_ 2700 K CRI >90 5712 lm 82 lm/W
- /2_ 3000 K CRI >80 5180,34 lm 75 lm/W

Control

- 2332 __ / _ 1 DALI
- 2332 __ / _ 3 1-10V
- 2332 __ / _ Z Casambi

Materials

Diffuser: PMMA. Canopy: Steel

Light Source and electronics

3 x LED STRIP 24V 23 W
Constant Voltage 24V
100~277V 50/60Hz

Packaging

1 Box 0,60 x 0,60 x 0,27 m
Vol 0,0972 m³
Gross weight 14,75 Kg Net weight 8,75 Kg



2333

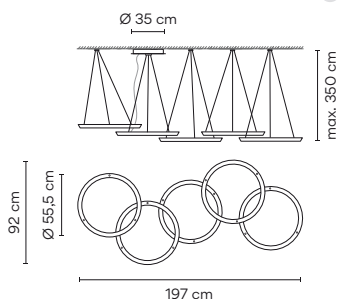

Finishes

- 03/ __ White (RAL 9016)

LED Colour Temperature

- /1_ 2700 K CRI >90 9520 lm 82 lm/W
- /2_ 3000 K CRI >80 8633,9 lm 75 lm/W

Control

- 2333 __ / _ 1 DALI
- 2333 __ / _ 3 1-10V
- 2333 __ / _ Z Casambi

Materials

Diffuser: PMMA. Canopy: Steel

Light Source and electronics

5 x LED STRIP 24V 23 W
Constant Voltage 24V
100~277V 50/60Hz

Packaging

2 Boxes
Total Vol 0,1106 m³
Gross weight 23,75 Kg Net weight 13,75 Kg



